

88 5178 80

Side Chair (Black Finish)

IMPORTANT NOTE

Carefully remove all the parts from the carton and put them individually on a soft cloth to prevent scratches or other damages occurring to the wood parts.

We have taken great care in the design of this product and request that you carefully and strictly follow our assembly instructions to ensure a completed product as it was designed.



Casual Attire For Today's Home

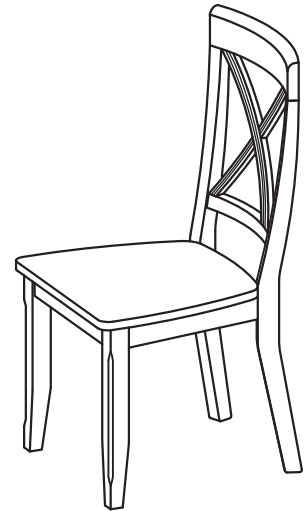

PART LIST

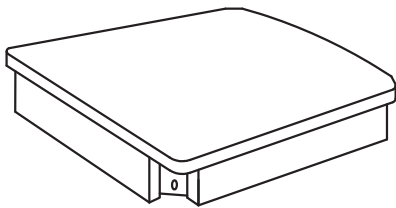

**A.
Seat**
1 pc.



**B.
Leg**
1 pc.



**C.
Leg**
1 pc.

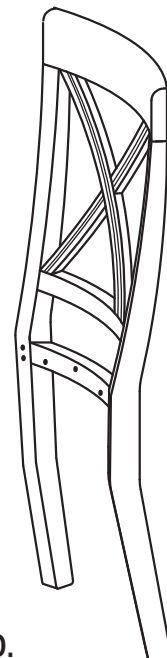

**D.
Back Frame**
1 pc.

HARDWARE LIST

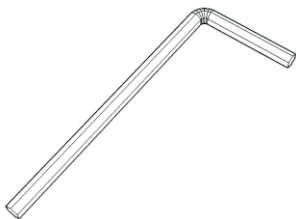

Key Wrench
1 pc.

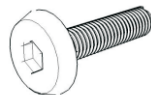

Bolt (Short)
3 pcs.(+1 extra)



Flat Washer
11 pcs.(+1 extra)

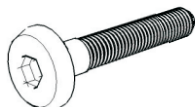

Bolt (long)
4 pcs.(+1 extra)

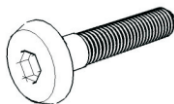

Bolt
4 pcs.(+1 extra)



Spring Washer
11 pcs.(+1 extra)

Home Styles Consumer Assistance Line 888-680-7460 and 877-831-0319
servicedesk@homestyles-furniture.com

Assembly Instructions

IMPORTANT

* Do not tighten up all the screws until each part is properly assembled.

* You should keep Hex Wrench in a safe place as you may need to tighten up the Head Cap Bolts in the future.

STEP 1

Attach Leg (B) and (C) to Seat (A) with Flat Washers, Spring Washers and Head Cap Bolts.

Tighten Head Cap Bolts only half way.
(See figure 1).

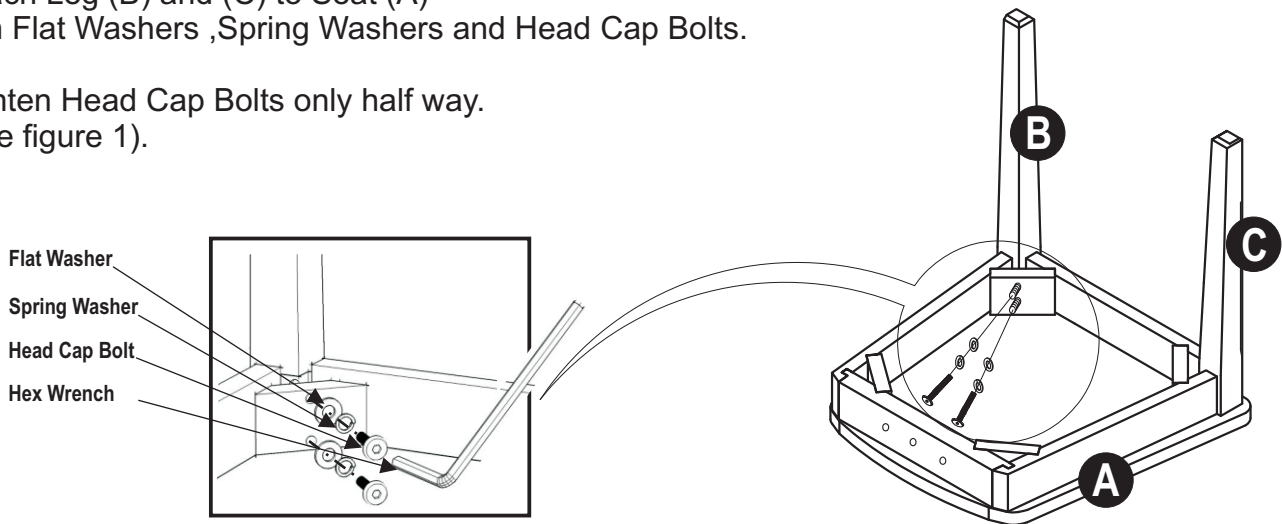

STEP 2

Attach the Back Frame (D) to the assembled unit with Flat Washers, Spring Washers, Head Cap Bolts (short) and Head Cap Bolts (long)

Tighten up all Head Cap Bolts.

